

SKSCR3011P

30" Integrated refrigerator

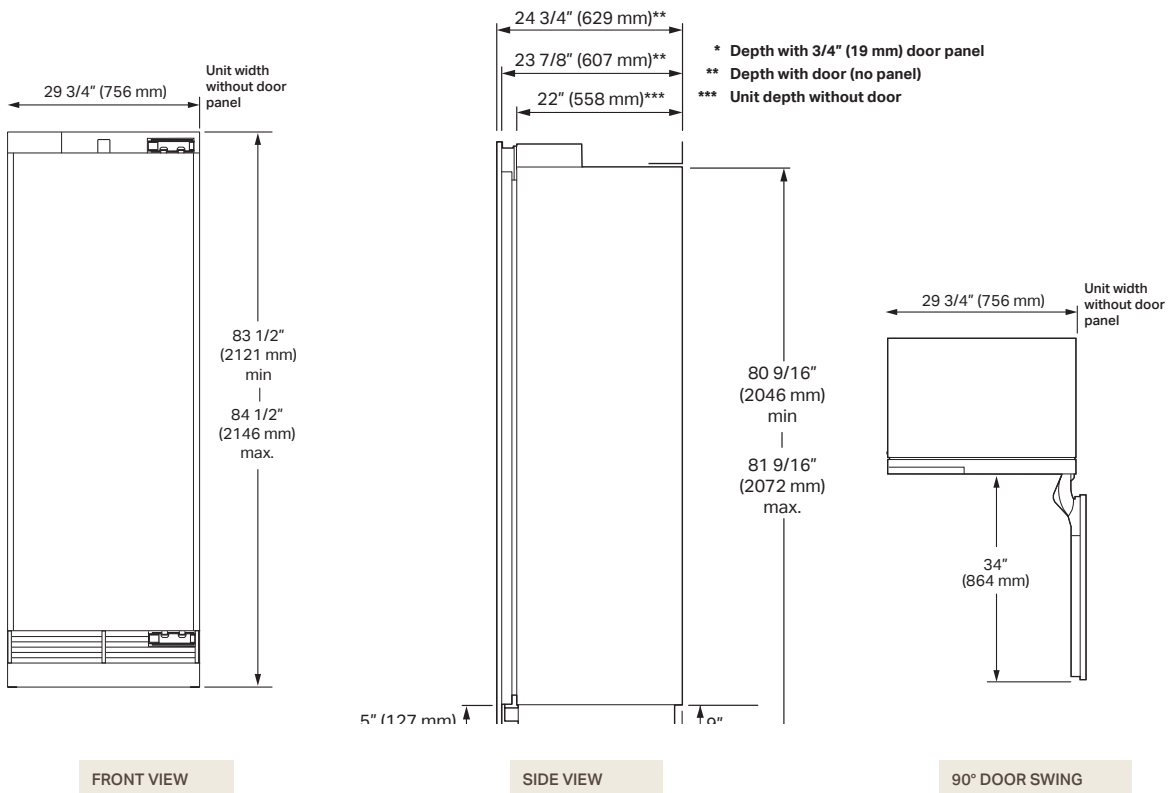

SKSCR3011P

Style

Door Style	Panel Ready
Hinges	Flat
Interior finish	Metal

Energy Label

Energy Efficiency Class	E
Net Total Capacity	502 L
Maximum Sound Level	< 39 dbA Max
ENERGY STAR® Qualified	●
Yearly total energy consumption (kW/h)	121
Climate class	SN-T

General Properties

No-Frost	●
Inverter Linear Compressor	●
Wi-Fi-Enabled for SmartThinQ® Control with iOS/Android App	●
Automatic Adaptive Defrost	●
Modes	Demo, Power On / Off, Temp Control, Water Filter Reset, Smart Diagnosis, WI-FI
Speed Chill	●
Integrated Water Dispenser	●
Connection to the water supply	●
Water Filter (6 Months)	●
Storage Shelves	3 Cantilever Adjustable
True-View® Lighting	●
Drawer design	3 with telescopic guides and soft close
Aluminium Door Bins with Removable Inserts	4 Cantilever
Digital Controls w/ White LED Display	●
Water Filter Indicator	●
Operating Temperatures	0°C to 6°C

Installation

Reversible Door	●
Four Point Front Adjustable with 4 Wheels	●
Attachment Method to Cabinetry	Top with No Visible Screws
Front Serviceable	●
Anti-tip Bracket Included	●

Technical Specifications

Required Power Supply	230V, 50Hz
Power Cord Length	2,200 mm (86.6")
Overall Width	756 mm (29.7")
Overall Height	2,121 mm ~ 2,146 mm (83.5" ~ 84.4")
Overall Depth	607 mm (23.8")
Net Weight	175 kg
Shipping Weight	201 kg

Accessories

Stainless Steel Panel / Handle / Toekick Kit	SKSPK305CS
Frame mounting Kit	SKSFK800CS
Medium brushed Aluminium Handle – 805 mm	SKSHK310HS
Long brushed Aluminium Handle – 1,218 mm	SKSHK480HS
Replacement Water Filter	LT1000P-S



Download
the User's
Manual

Cutout dimensions – flush or proud installation

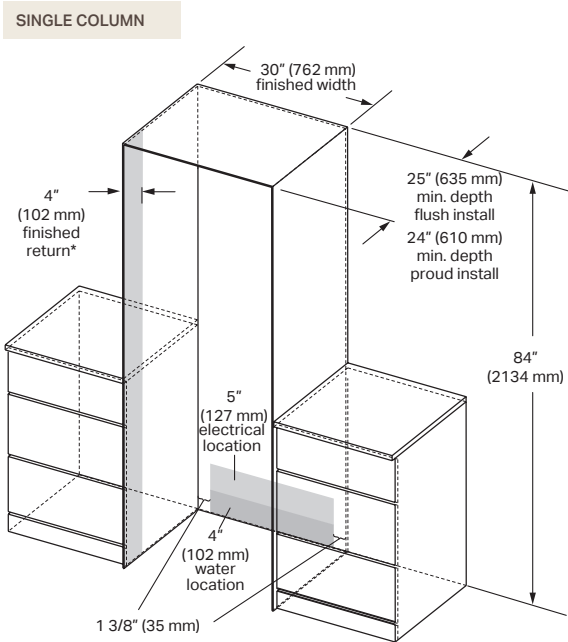

* A minimum 4" (102 mm) finished return that matches the cabinet exterior is recommended on all sides and the top of the cutout opening. The shaded area will be visible after installation.

Notes

The refrigerator can be installed flush or proud with 19 mm (3/4") custom panel or optional stainless steel panel kit.

Flush – with a 635 mm (25") cutout depth, the front face of the refrigerator fits flush with 635 mm (25") depth adjacent cabinets.

Proud – with a 610 mm (24") depth cutout, the front face of the refrigerator extends approximately 19 mm (3/4") beyond 610 mm (24") depth adjacent cabinets.

Electrical

A 230 V, 50 Hz, 15 or 20 A power supply is required.

An individual properly grounded branch circuit or circuit breaker is recommended. Install a properly grounded 3-prong electrical receptacle recessed into the back wall. Electrical must be located on rear wall as shown.

Water Line

A cold water supply is required for water dispenser operation.

Water pressure must be between 1.37 and 8.27 bar (20 and 120 p.s.i.).

Tubing should be long enough to extend to the front of the refrigerator. Allow enough tubing to accommodate a bend leading into the water line connection. Water line can go through an opening in the floor or back wall. Install a shut-off valve between the dispenser's water valve and cold water supply in the home.

Installation clearances

FRONT VIEW

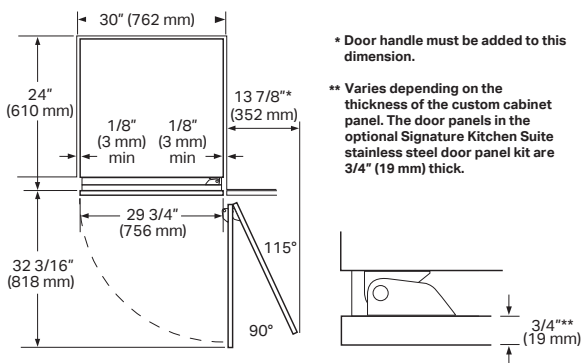

* Door handle must be added to this dimension.

** Varies depending on the thickness of the custom cabinet panel. The door panels in the optional Signature Kitchen Suite stainless steel door panel kit are 3/4" (19 mm) thick.

Notes

Door Swing Clearances – the installation must allow for clearances to adjacent walls or cabinets. This freezer is equipped with a 2-position door stop. The factory-set 115° door swing can be adjusted to 90° if clearance to adjacent cabinets or walls is restricted.

Door Handle Clearances – the Door Handle depth must be added to the dimension noted to determine the total clearances required from adjacent cabinets or walls. This clearance will vary depending on the custom handle used. When using the Stainless Steel Door Panel Kit w/ Handle or the Brushed Aluminium Handle (optional accessories), the door handle clearance with door open 115° is 457 mm (18").

Custom panel dimensions – flush installation

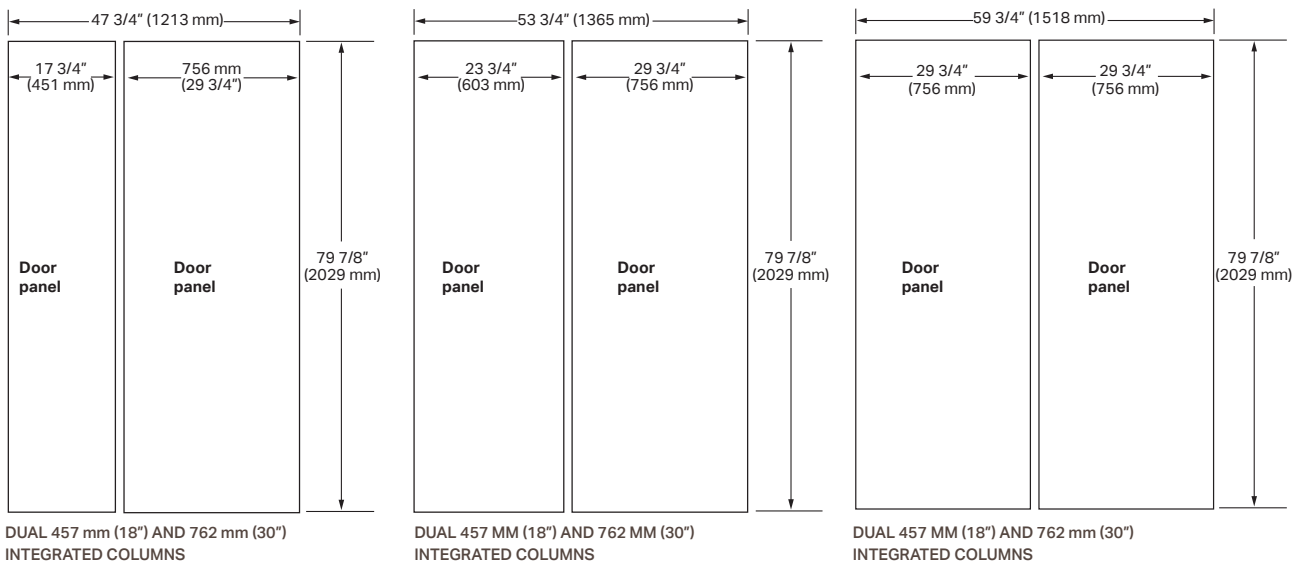

Notes

These units are designed to be customized with decorative panels. Field installed, custom door panels or with an optional Stainless Steel Panel Kit is required.

For Custom Panels: use templates provided with units to pre-drill holes for mounting panel brackets (provided with unit). Adjustment screws and instructions also provided with the product.

Maximum Total Door Panel Weights:

- 75.6 cm (30") – 29 kg (64 lb) Integrated column;
- 60.3 cm (24") – 24 kg (53 lb) Integrated column;
- 44.5 cm (18") – 20 kg (44 lb) Integrated column

Design Tips

102 mm (4") will be visible on the interior sides of the furniture return. It is recommended that both sides of each cutout panel be finished to match the cabinet exterior.

If using custom panels, a custom toe kick is required. The bottom of case is unfinished.

Door Handles: handles are not included with the product. Custom handles are required for installation. Brushed aluminium handles are available as an optional accessory.

Optional accessories – flush or proud installation

SKSPK305CS: Stainless Steel Pane Kit

This unit can be installed with an optional stainless steel panel kit. Kit includes one door panel, one toe kick and one handle. This kit is reversible and can be used in both Right Hand and Left Hand door swing installations.

SKSFK800CS: Frame mounting Kit

This unit can be installed in a 610 mm (24") deep cutout with an optional frame kit. This kit includes two 2,032 mm (80") brushed aluminium side trim pieces. Each trim piece is 127 mm (5") deep with a 3 mm (1/8") front face.

SKSHK310HS: Handles with Custom Panels M

805 mm (31 11/16") Medium handle – Brushed aluminium

SKSHK480HS: Handles with Custom Panels L

1,219 mm (48") Long handle – Brushed aluminium

Design Tips

The Stainless Steel Panel Kit may be used in a flush 635 mm (25") cutout depth installation or in a proud 610 mm (24") cutout depth installation.

For retrofit/replacement installations where the existing cutout is 610 (24") mm deep, the optional frame mounting kit is recommended.